

**HARLEY - DAVIDSON**

# PARTS LIST

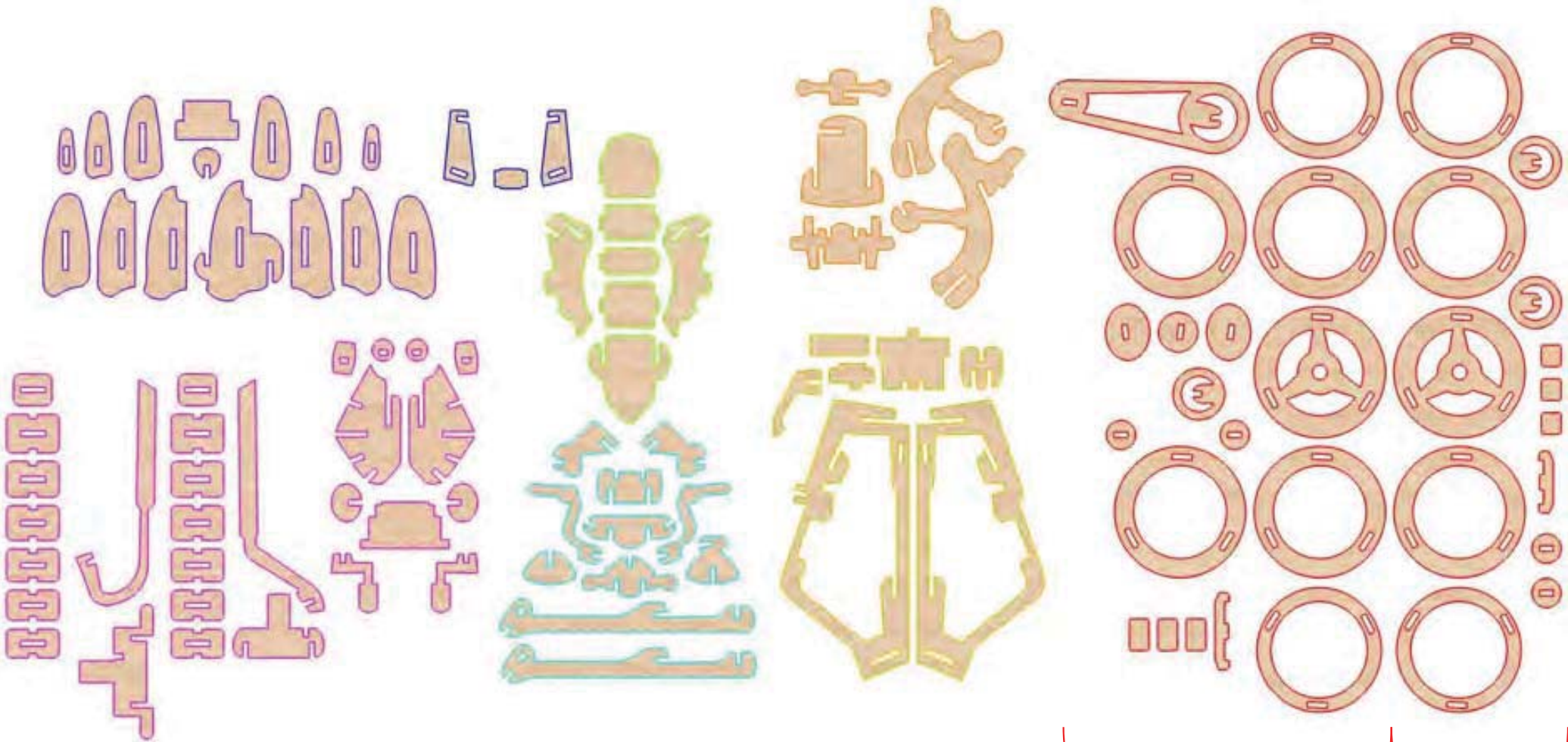

- SEAT —
- FUEL TANK —
- OIL TANK —
- REAR FENDER —
- FRAME —
- FRONT FORK —
- & STEERING HANDLEBARS —
- WHEELS —
- MOTOR —

REAR FRONT

# ASSEMBLY STEPS

## FRAME

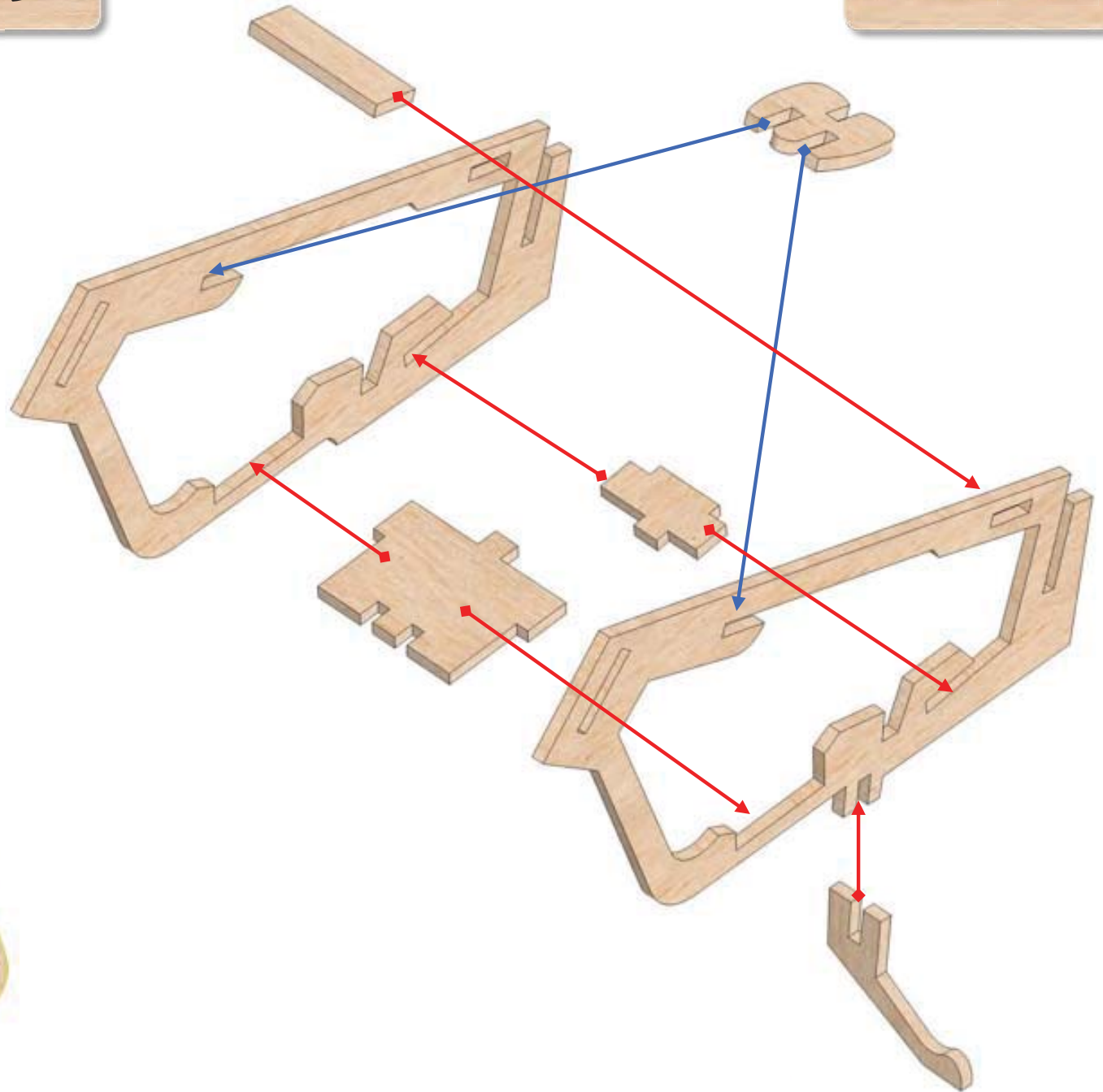
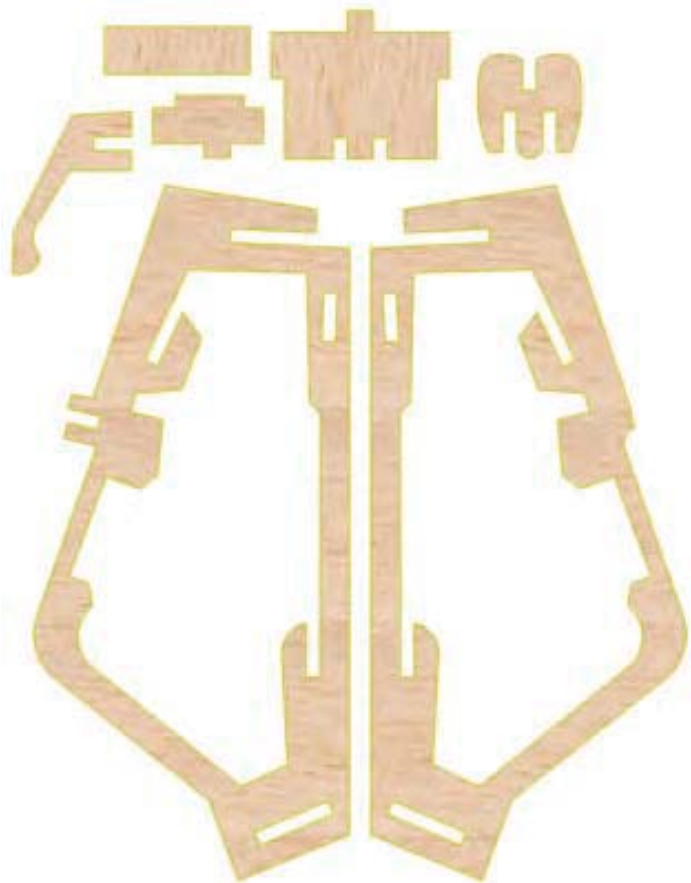

## FRONT FORK & STEERING HANDLEBARS

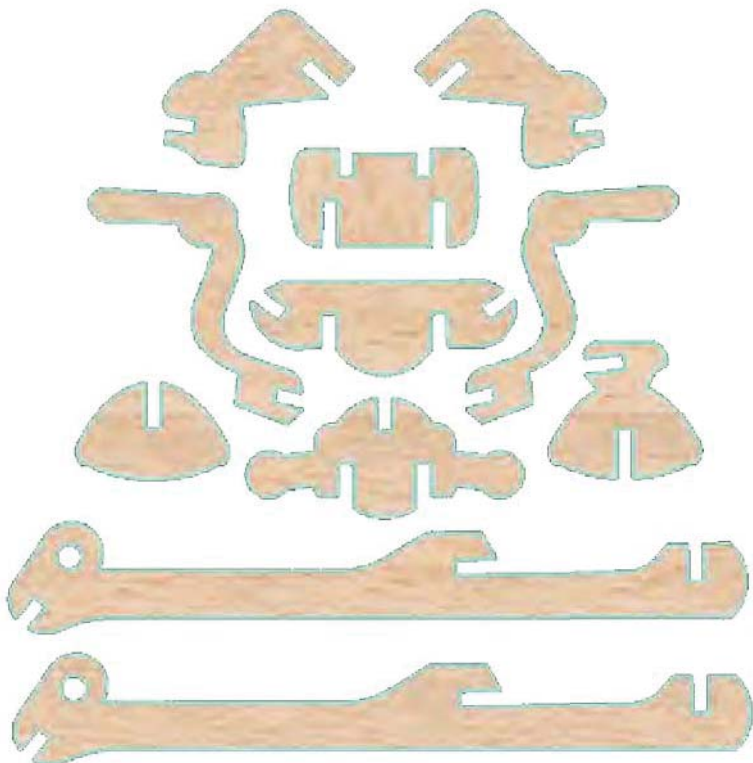
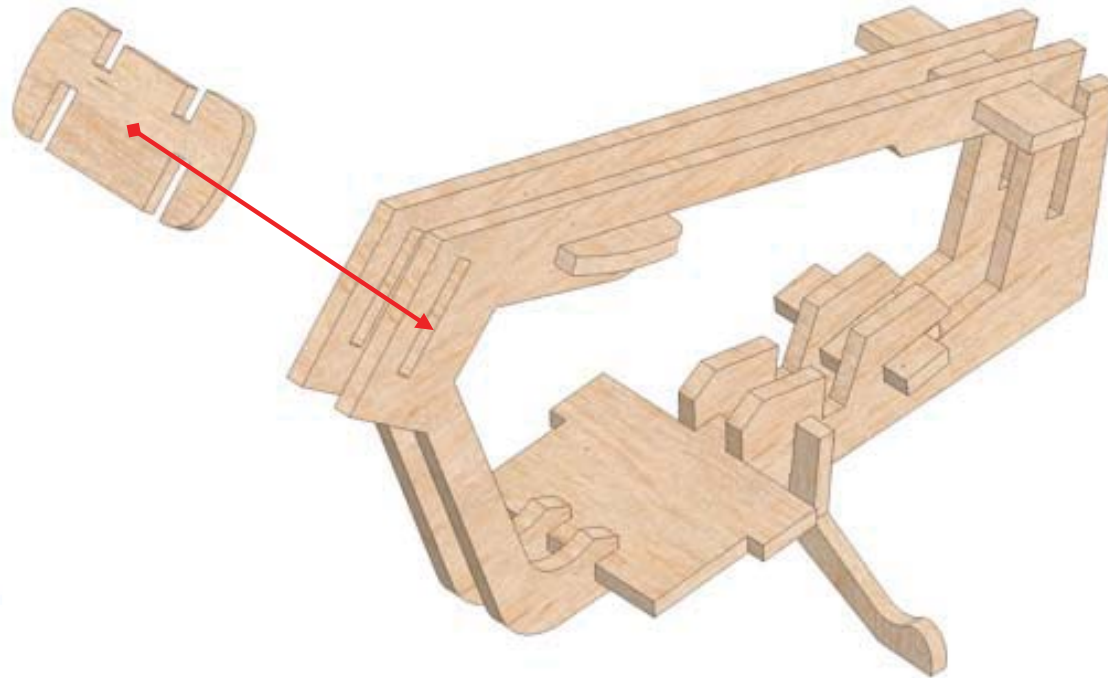

# ASSEMBLY STEPS

## FRONT FORK & STEERING HANDLEBARS

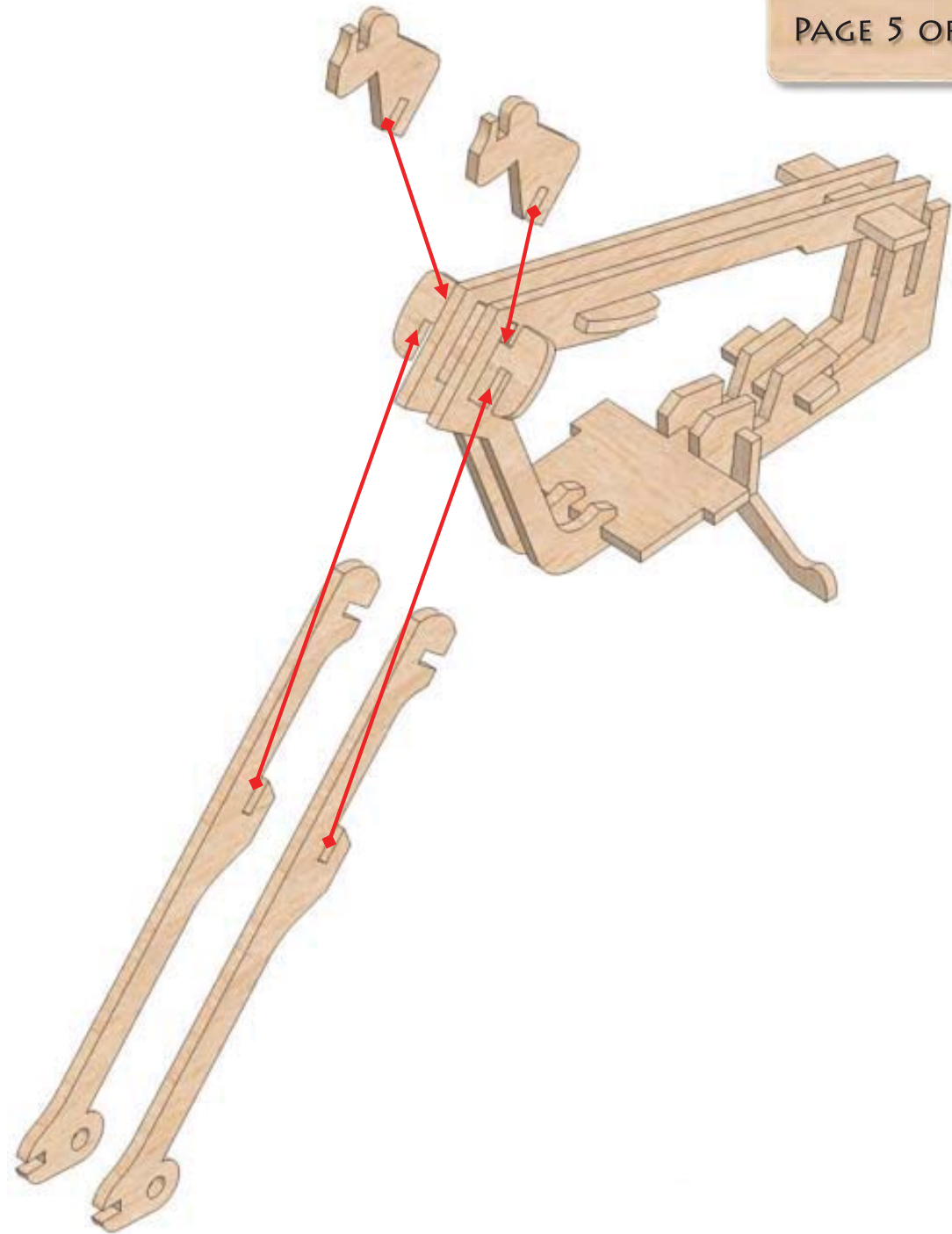
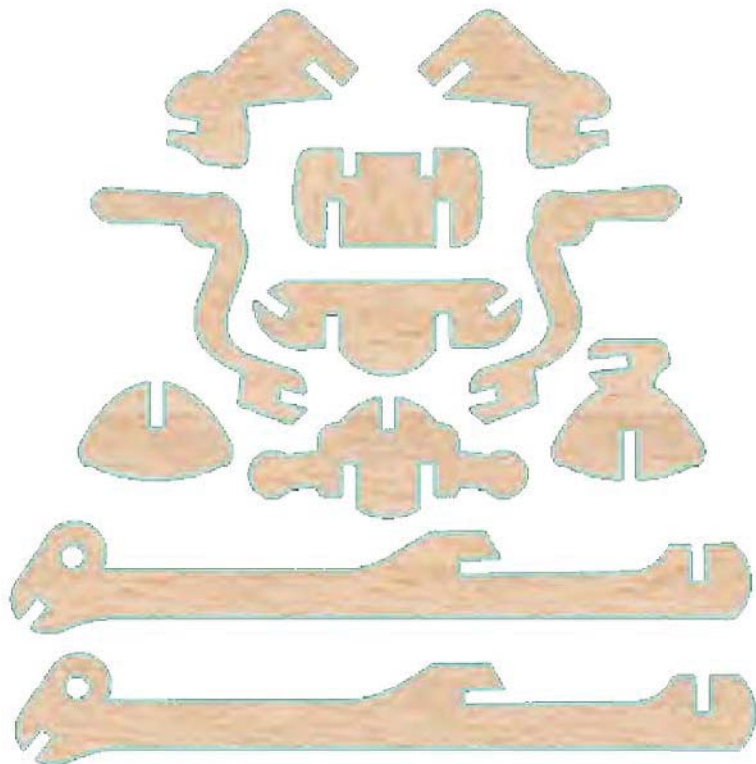

# ASSEMBLY STEPS

## FRONT FORK & STEERING HANDLEBARS

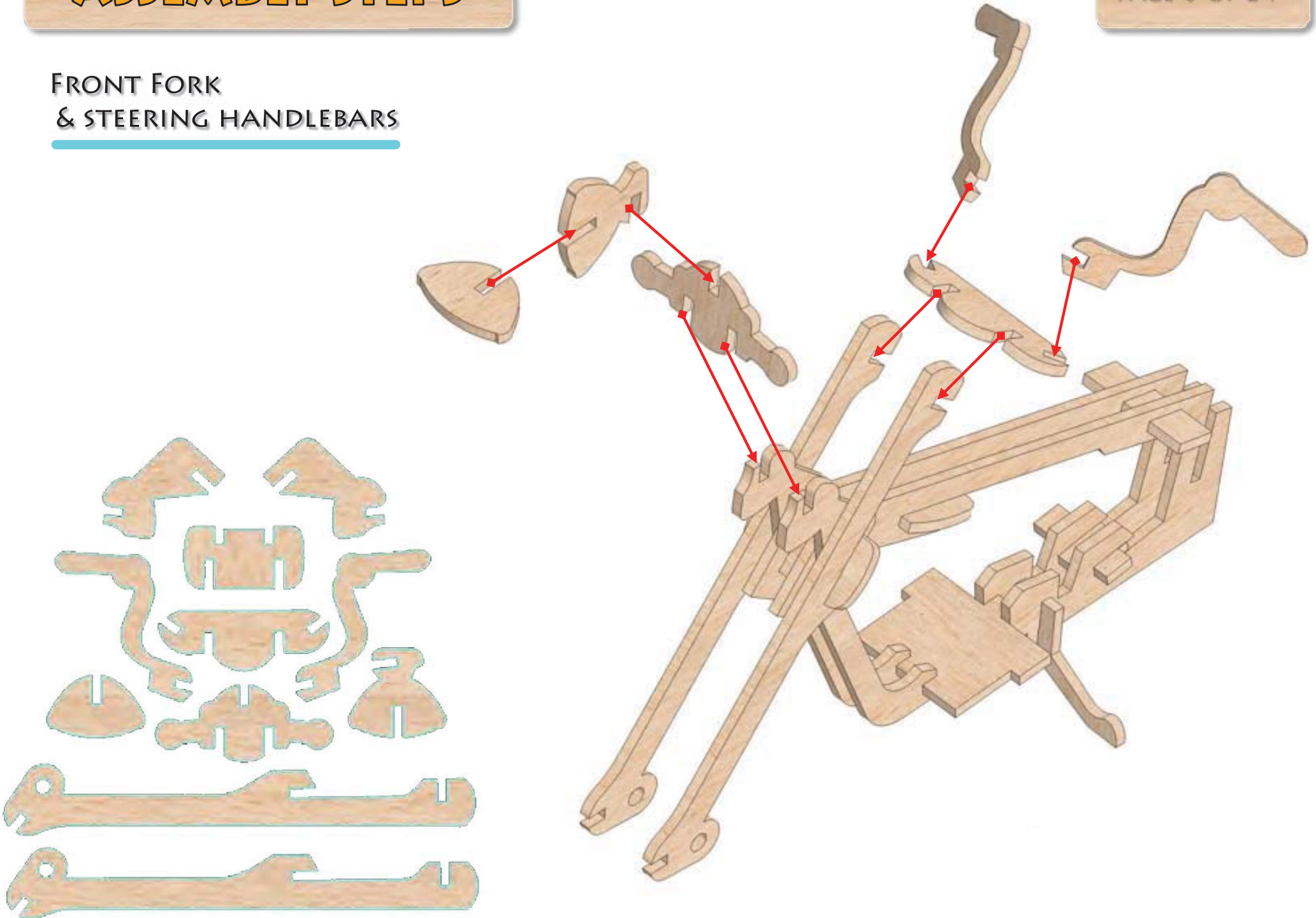

# ASSEMBLY STEPS

MOTOR —

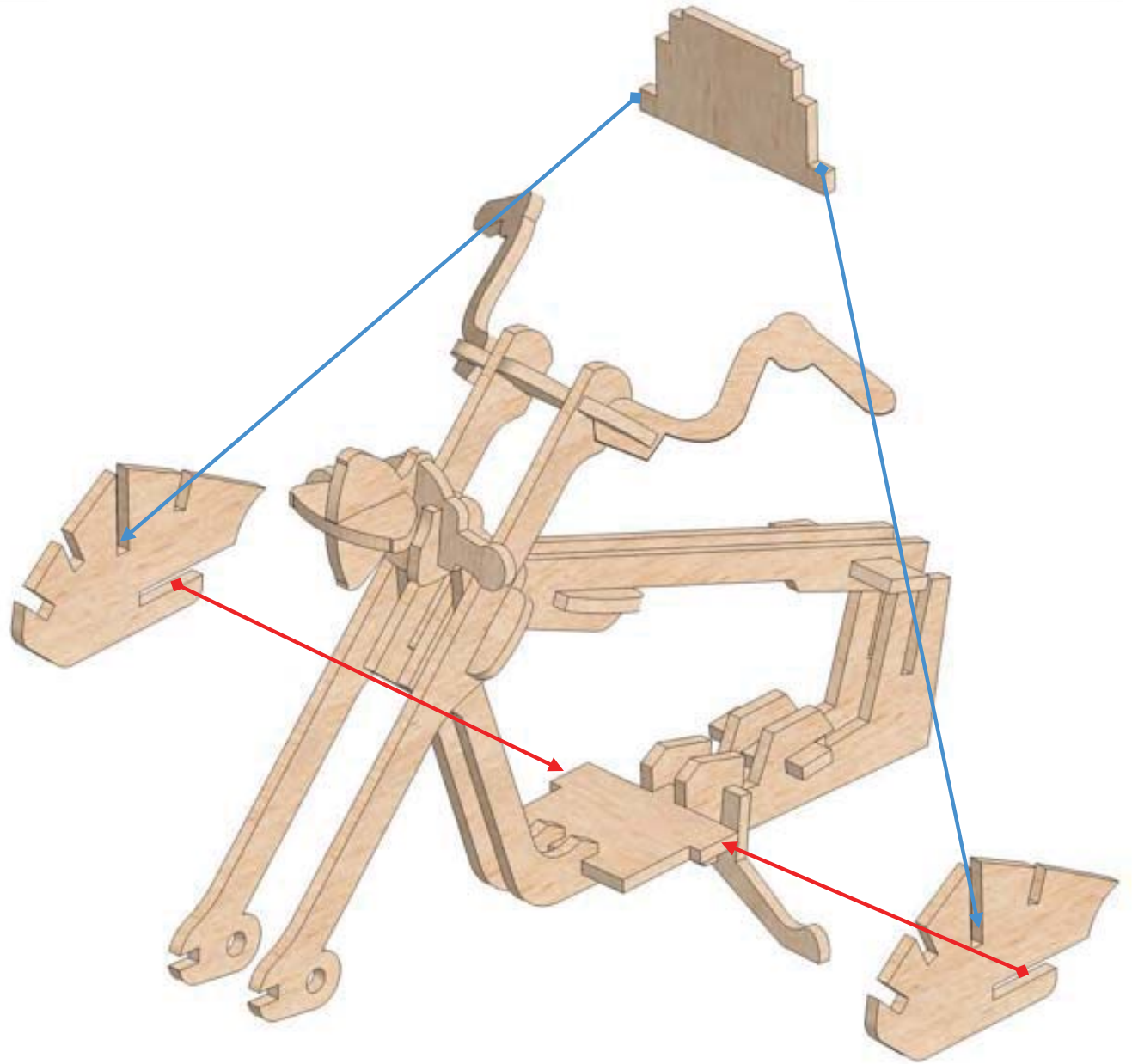
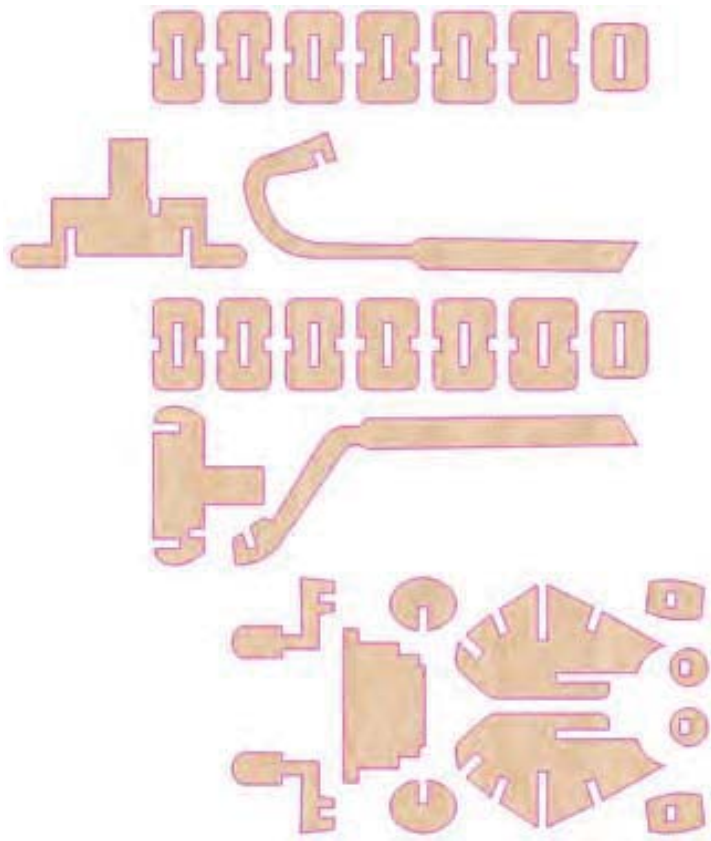

# ASSEMBLY STEPS

MOTOR —

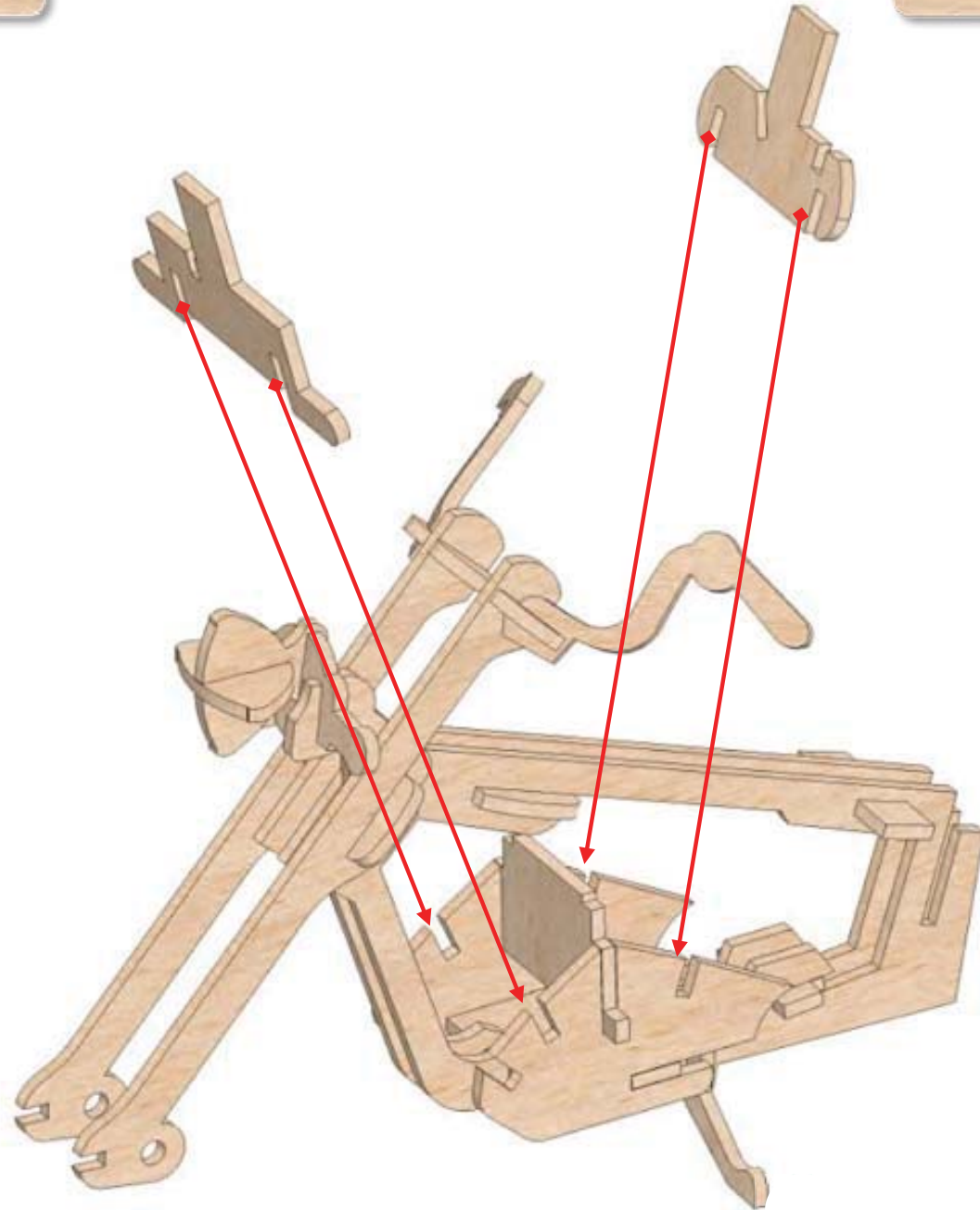
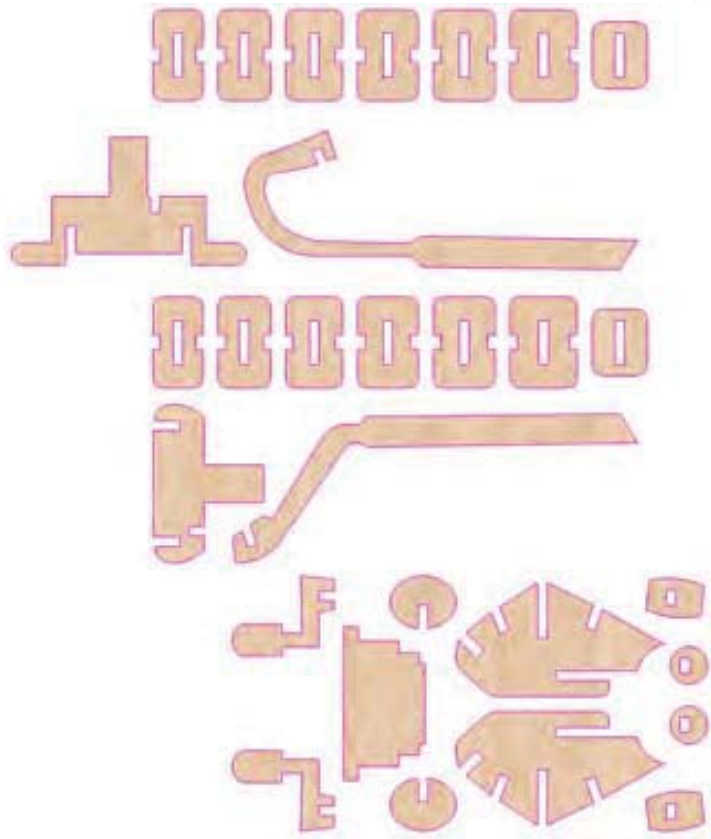



# ASSEMBLY STEPS

MOTOR —

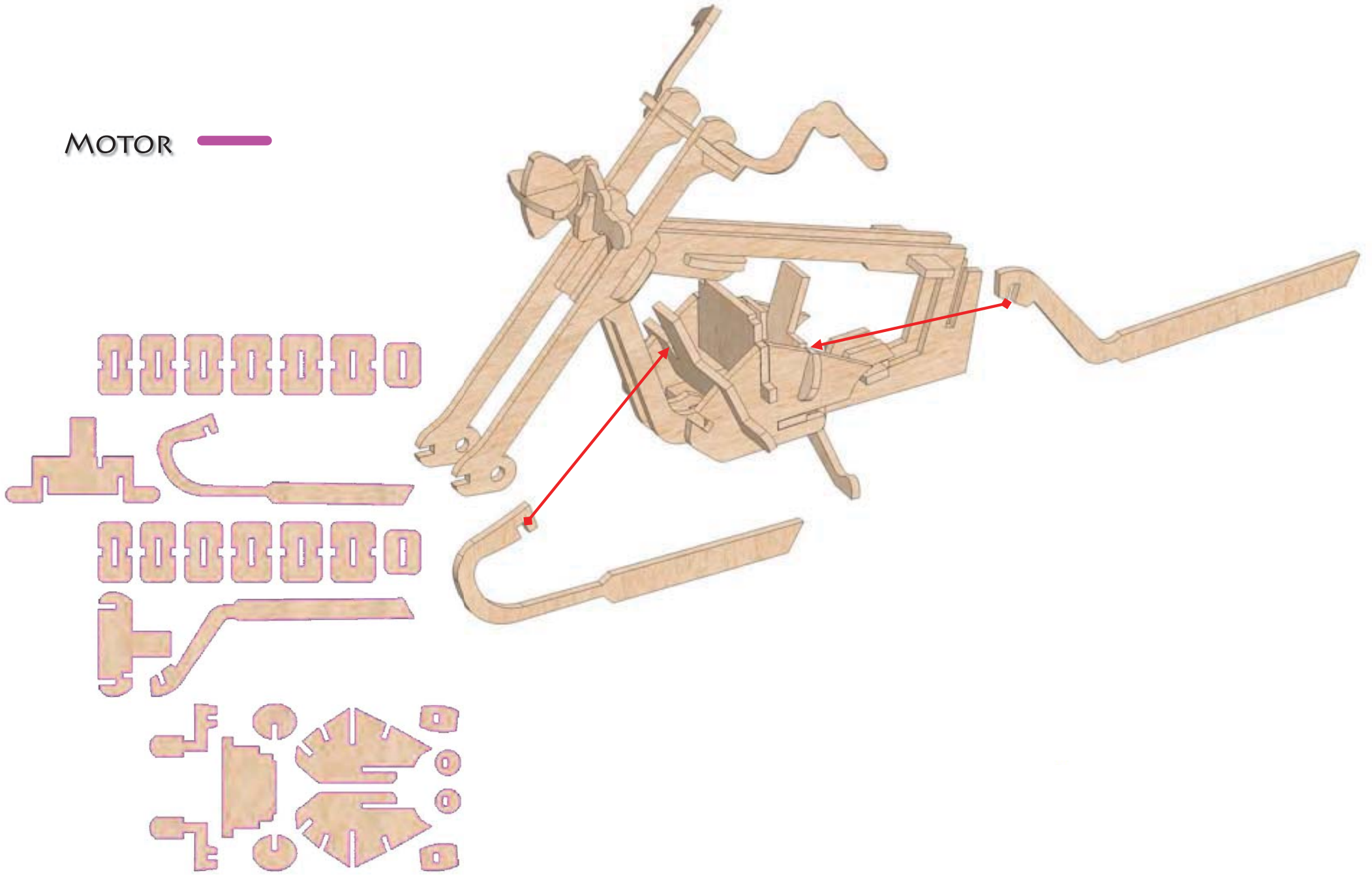



THE SAME CONNECTION ON THE OPPOSITE SIDE

MOTOR —

1. . . . . 7.

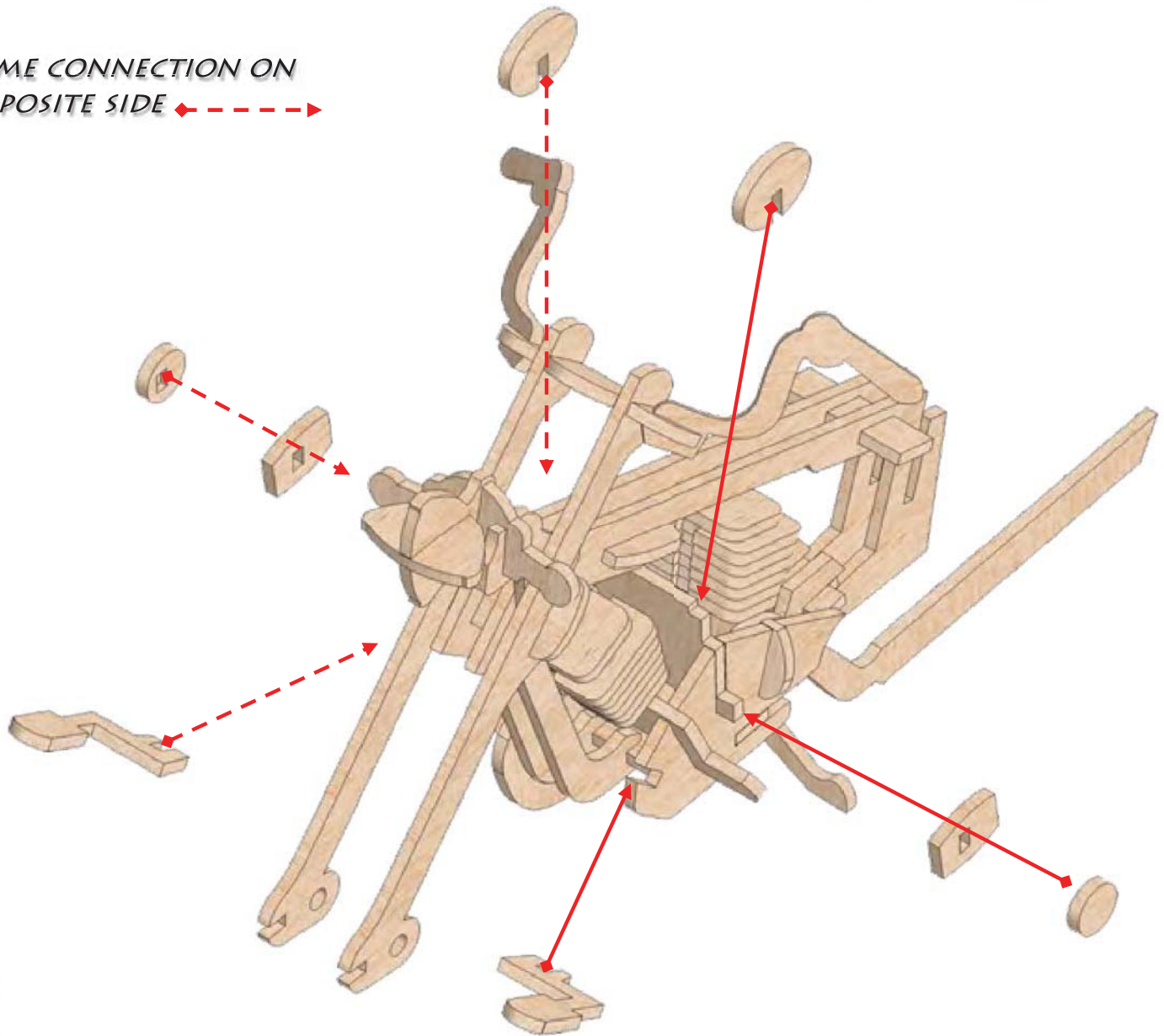
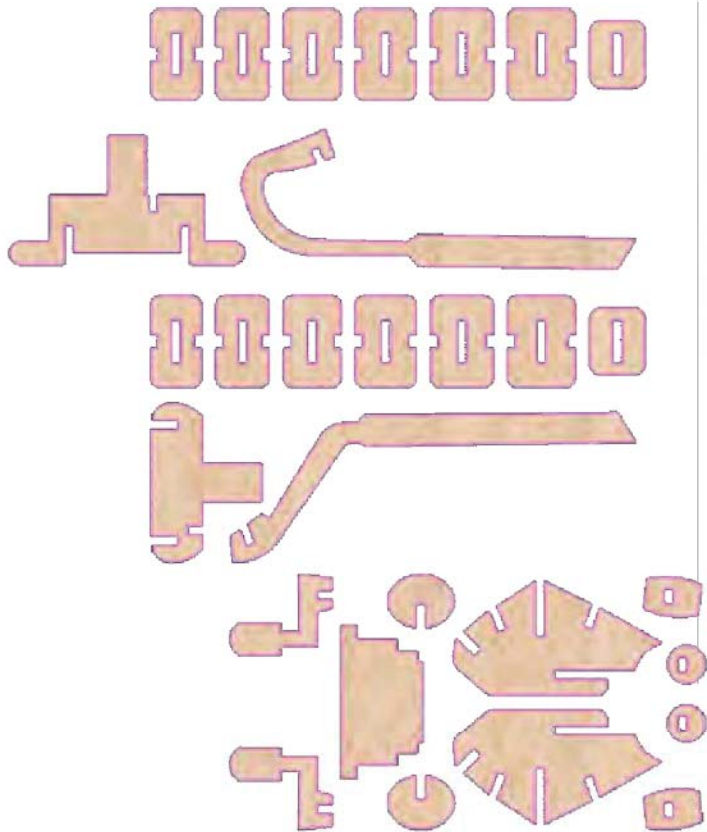

# ASSEMBLY STEPS

POCKET CUTS,  
3,5MM DEEP ON  
BOTH OUTER PARTS

ASSEMBLED WHEEL

WHEELS  
(FRONT)

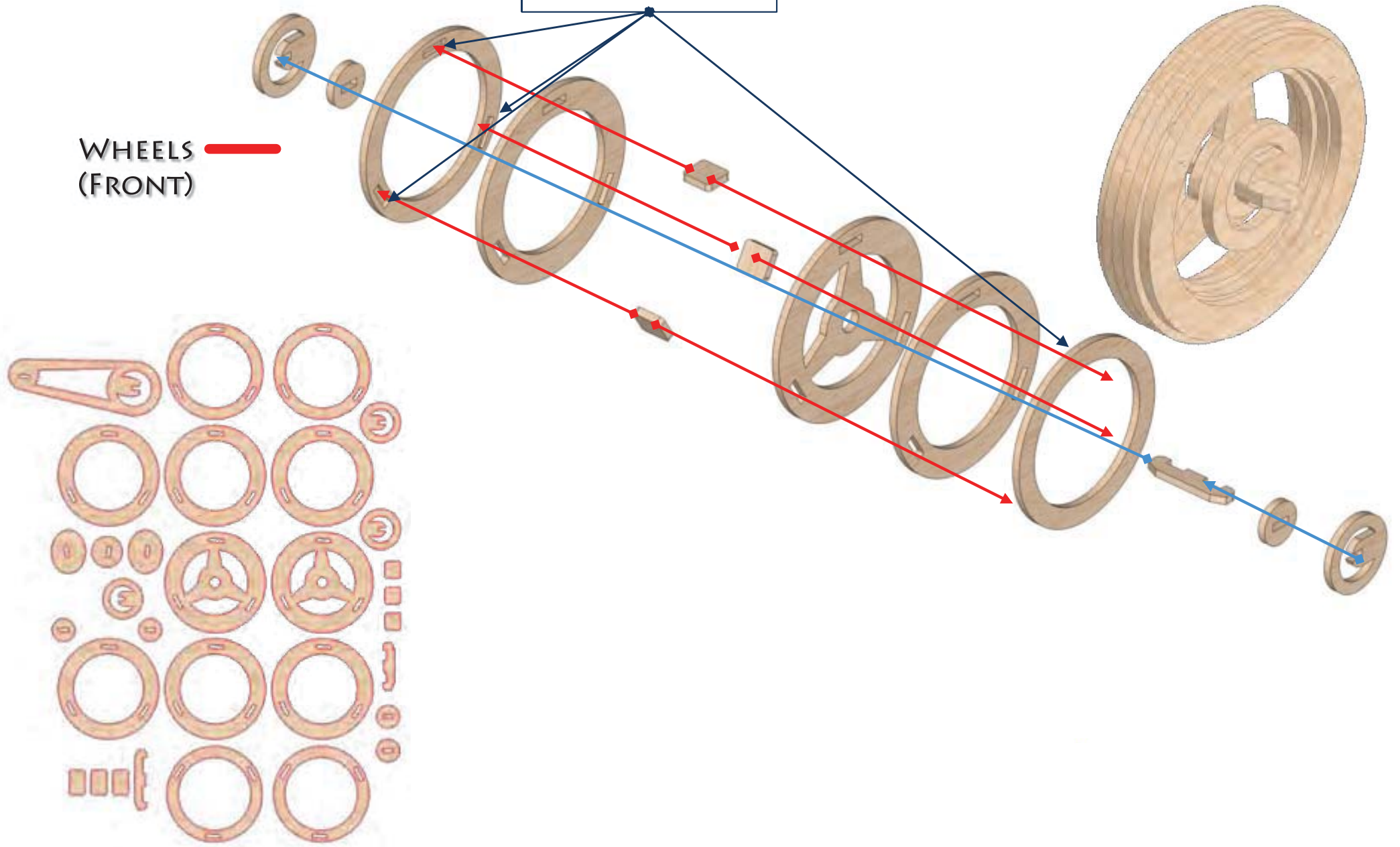

WHEELS —  
(FRONT)

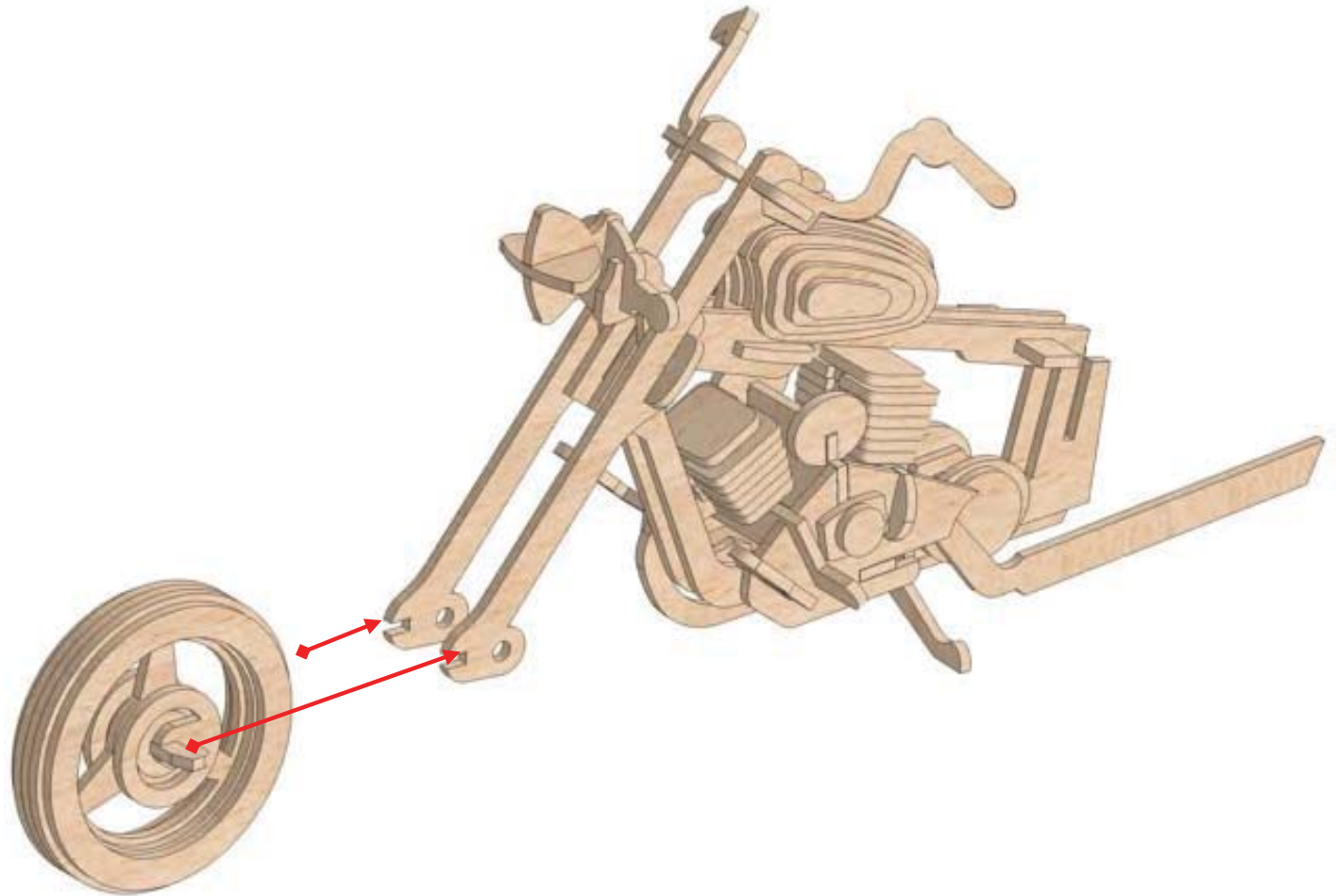
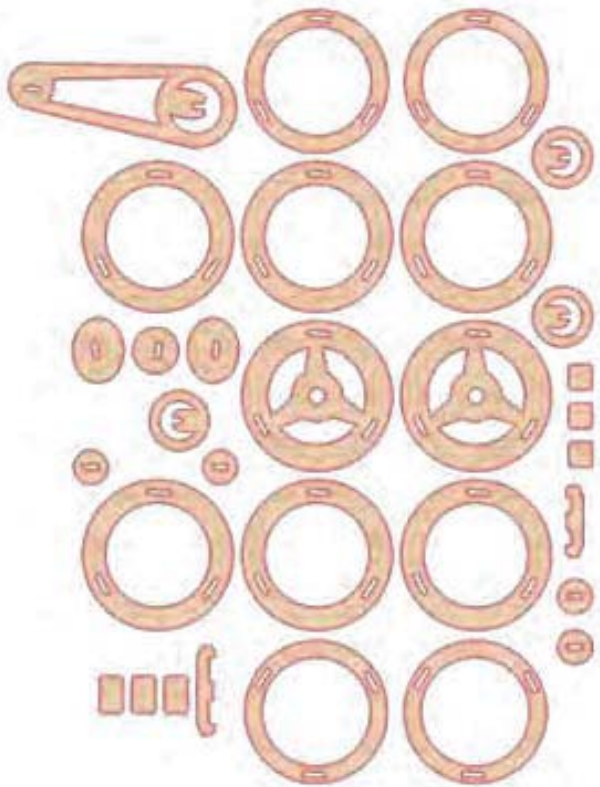

# ASSEMBLY STEPS

FUEL TANK —

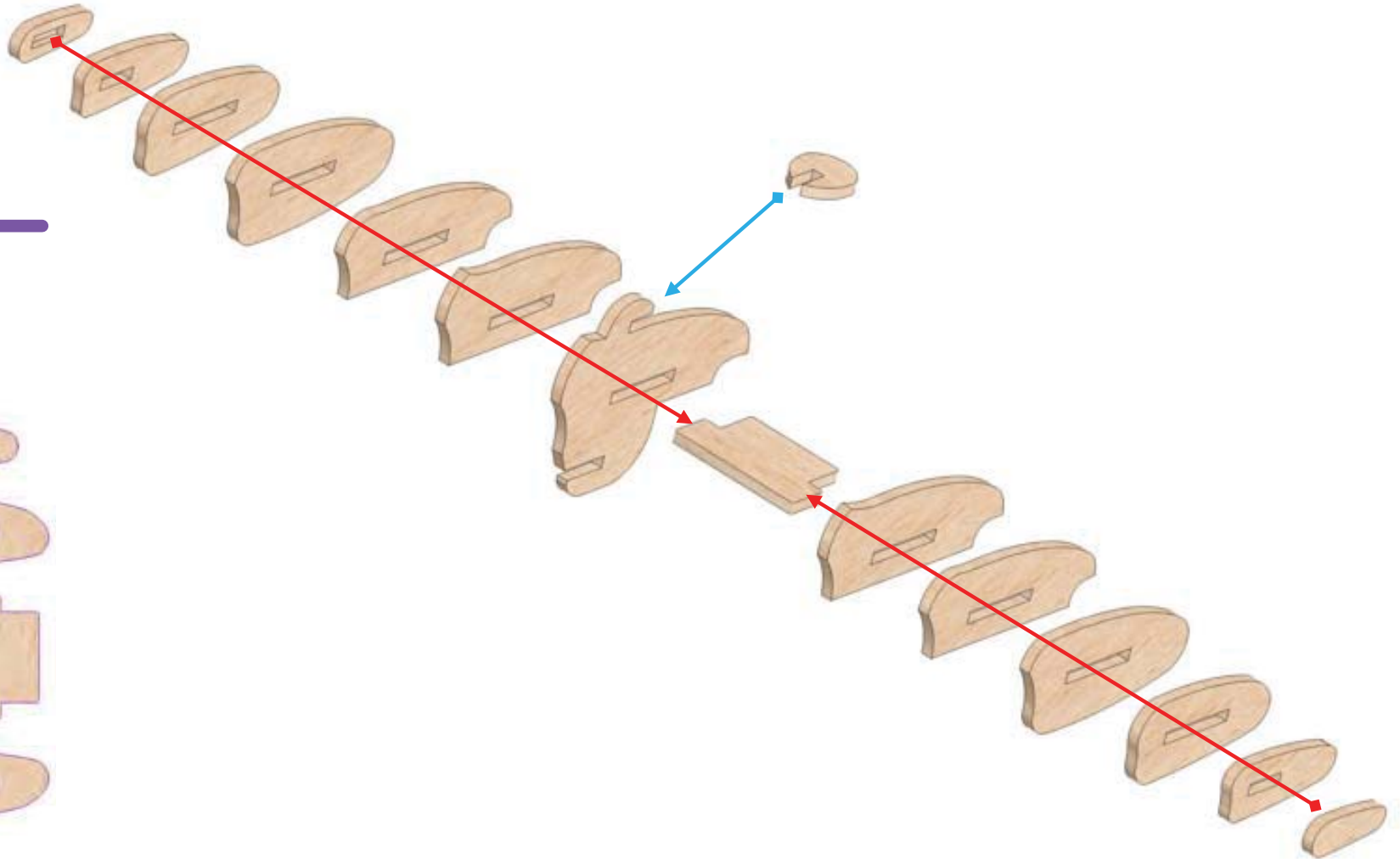
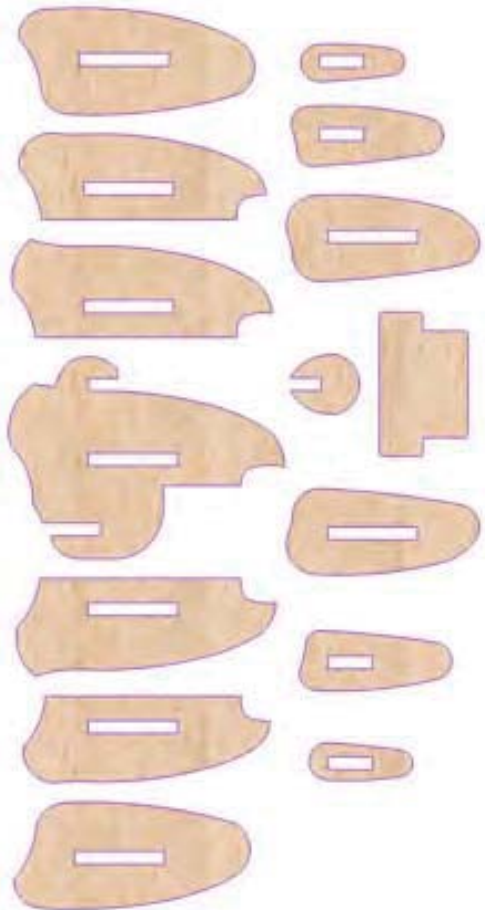

# ASSEMBLY STEPS

LEFT SIDE OF THE FRAME IS REMOVED FOR VIEWING PURPOSES

FUEL TANK —

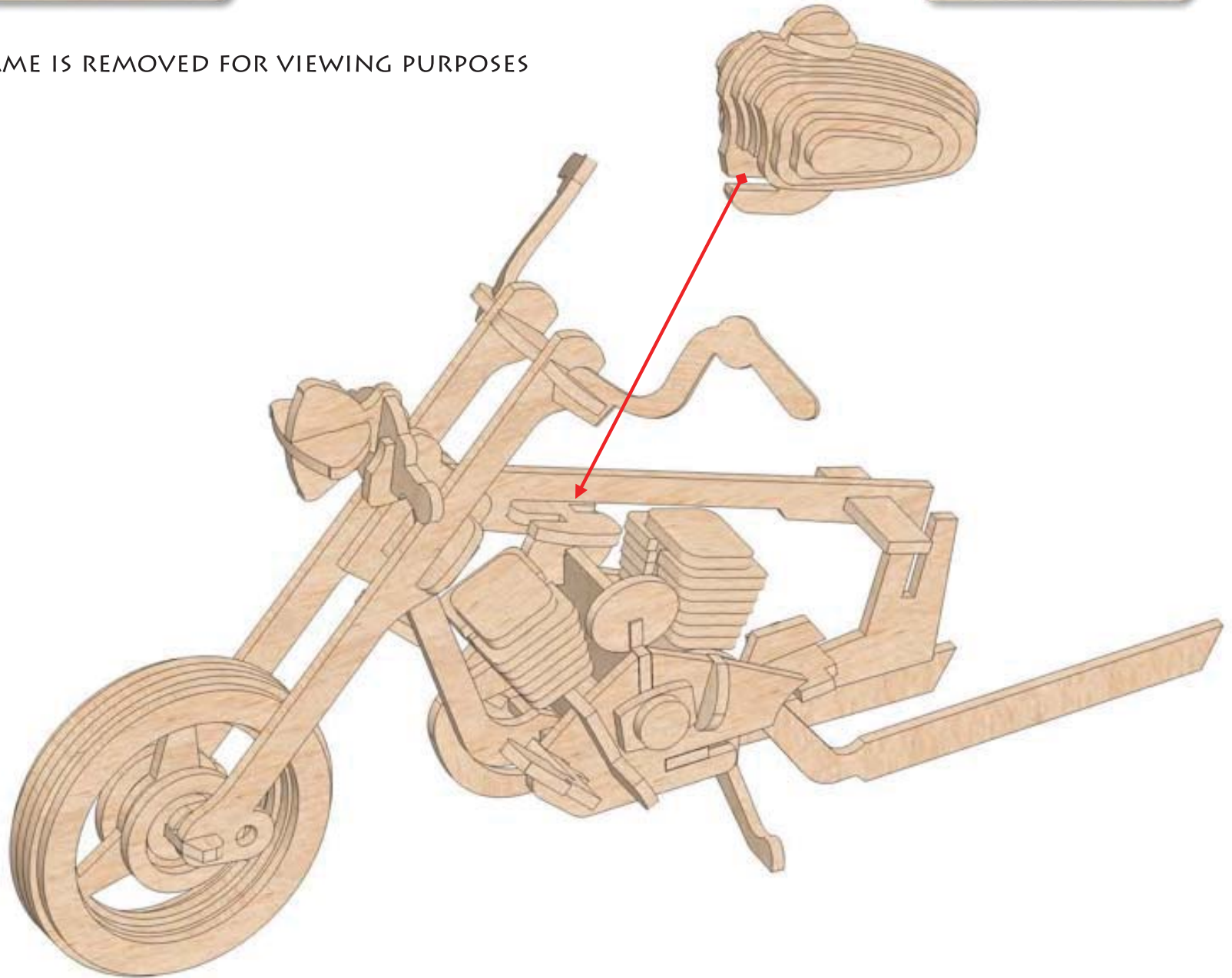
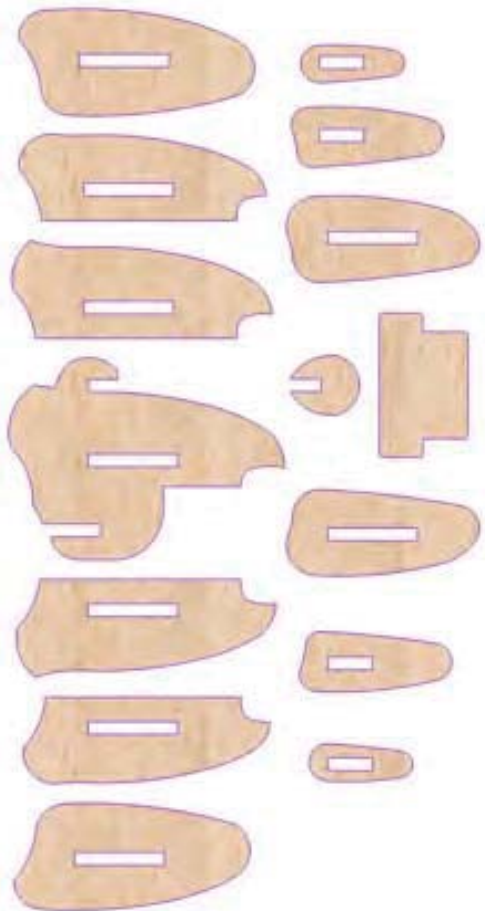

REAR FENDER —

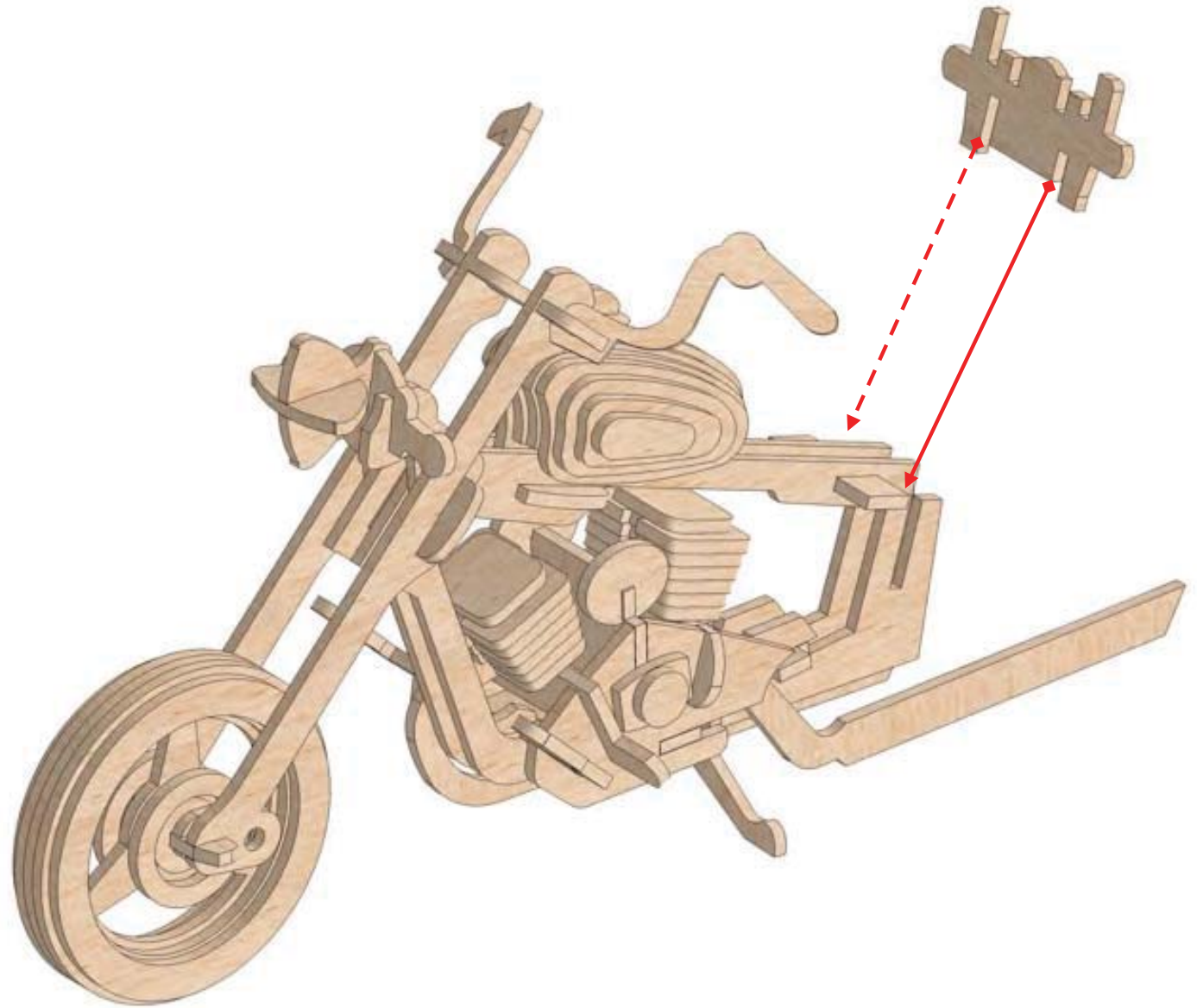



# ASSEMBLY STEPS

OIL TANK —

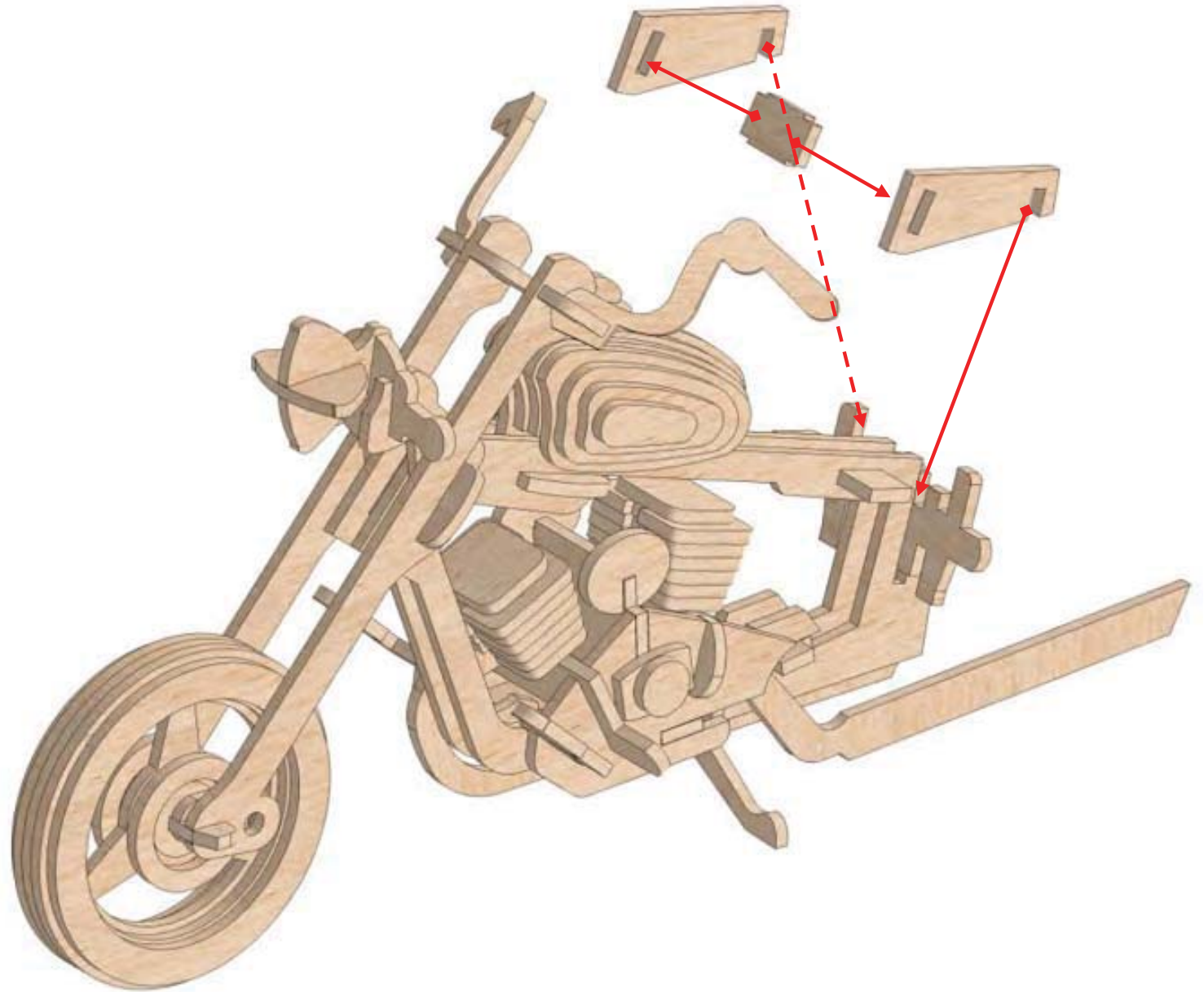

# ASSEMBLY STEPS

REAR FENDER —

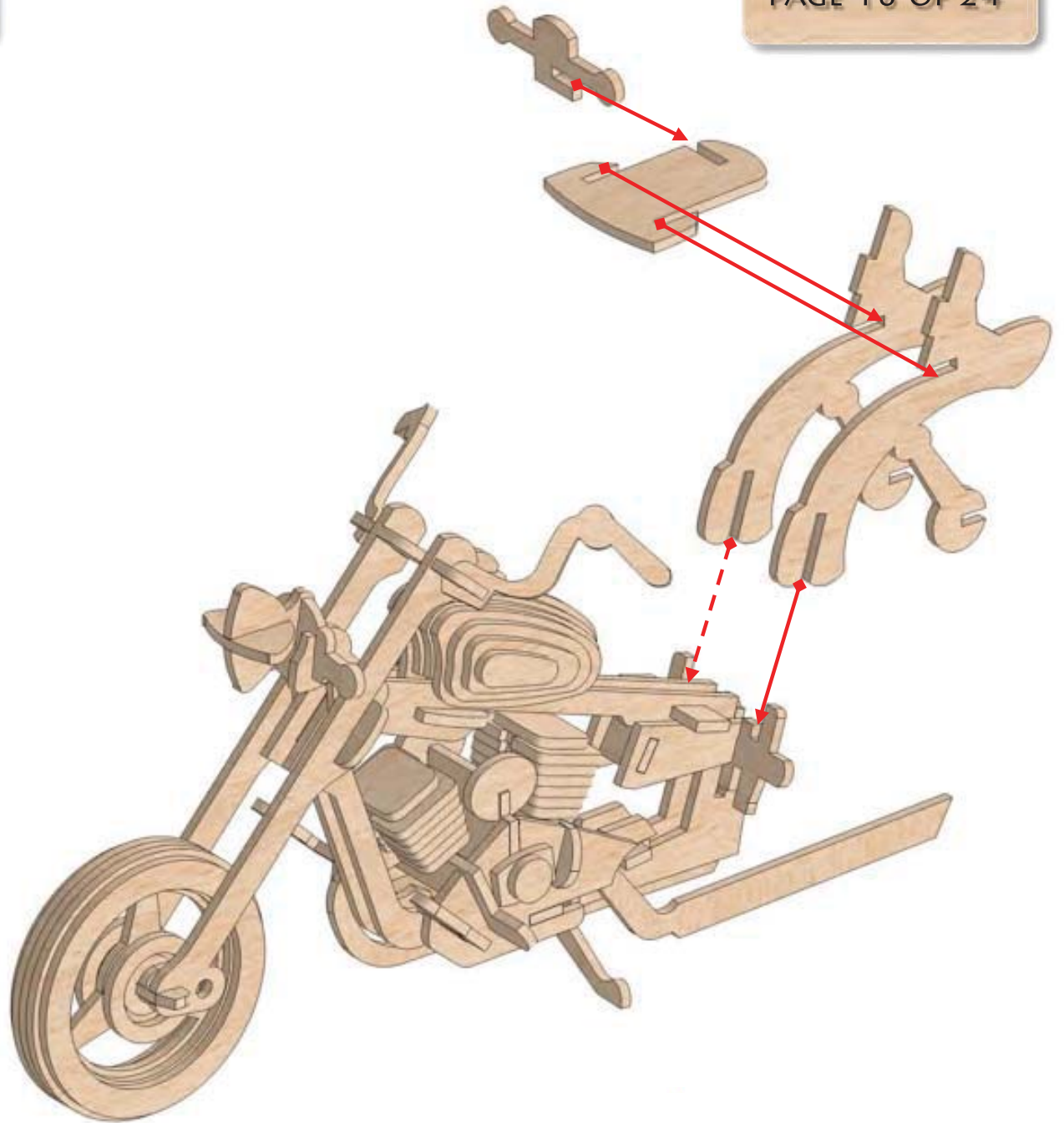

SEAT —

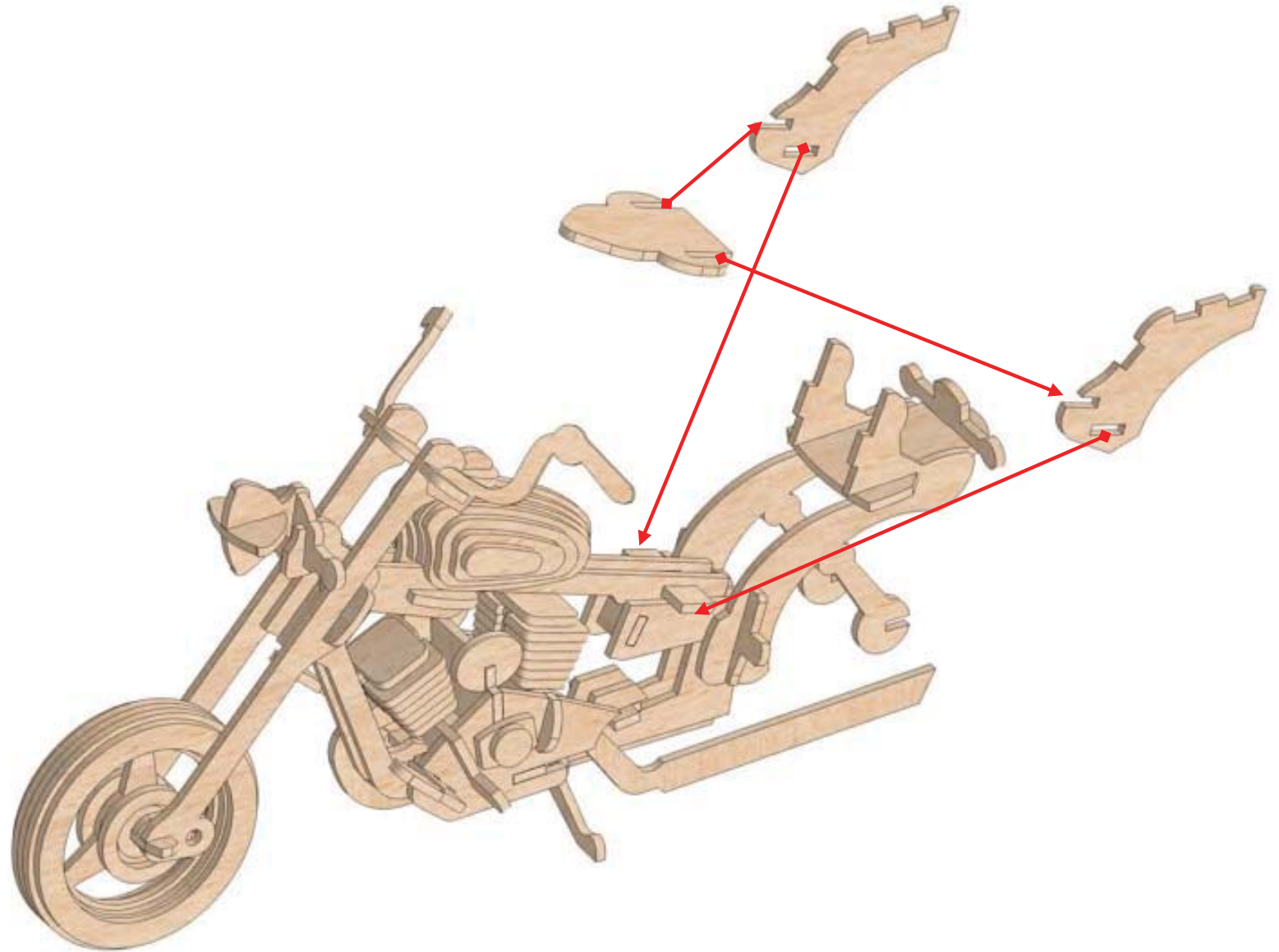

SEAT —

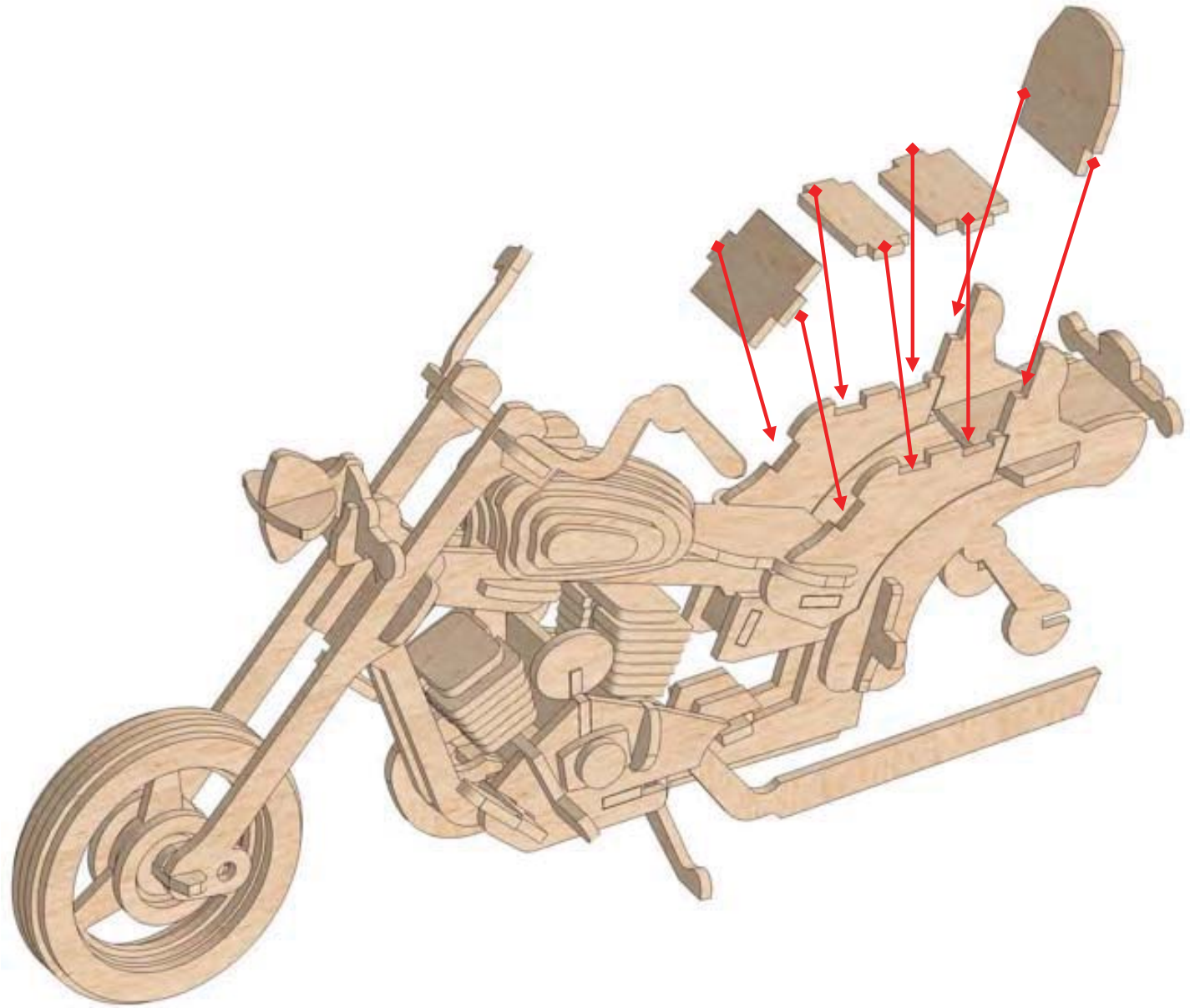

# ASSEMBLY STEPS

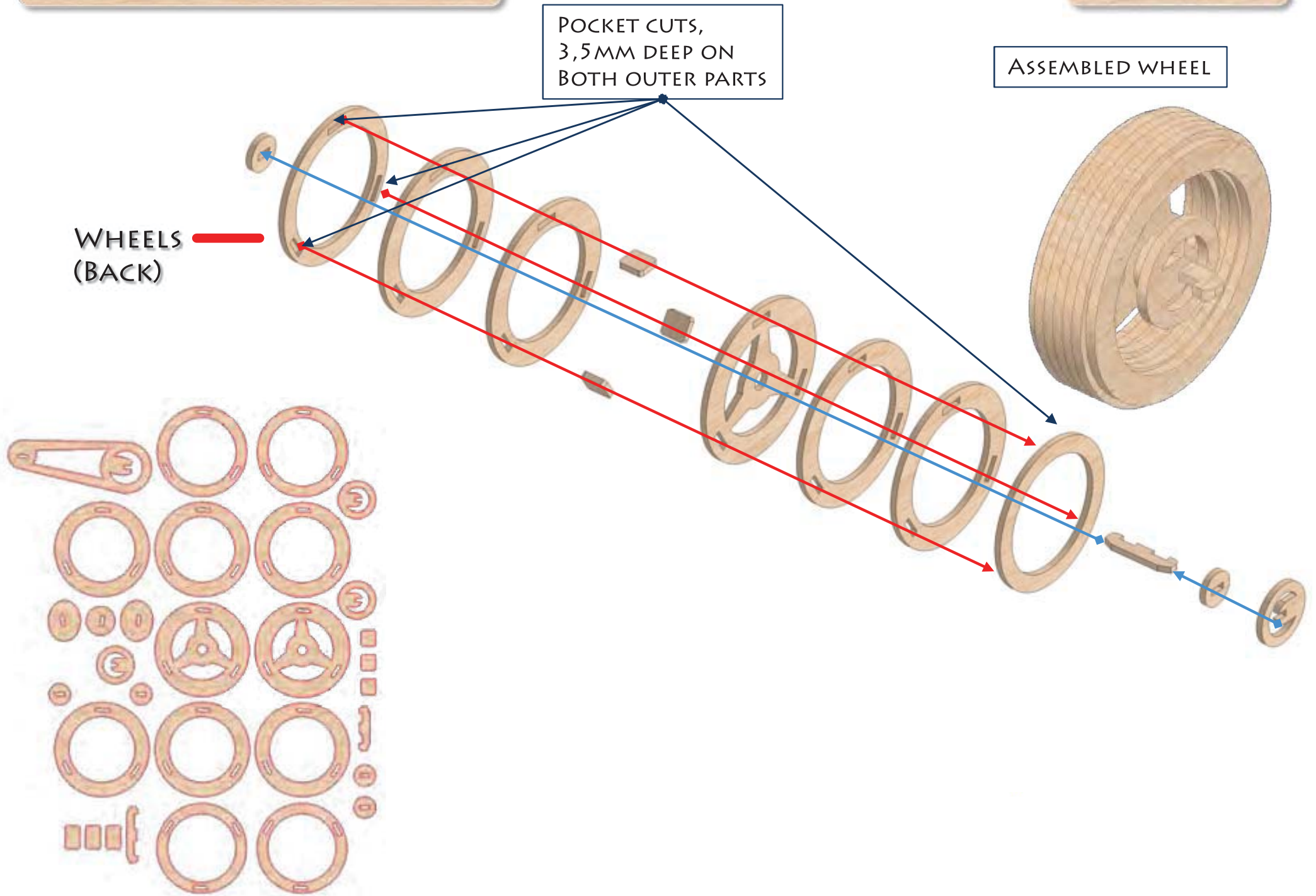

WHEELS  
(BACK)

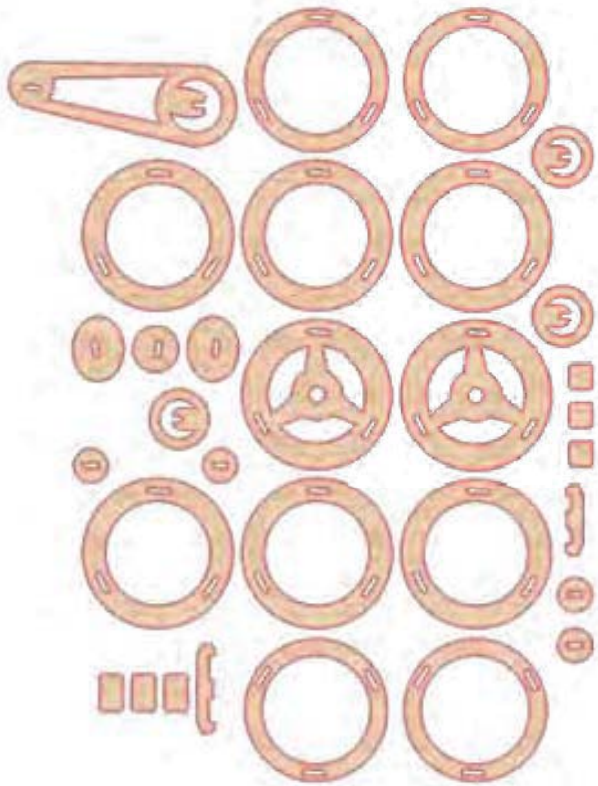
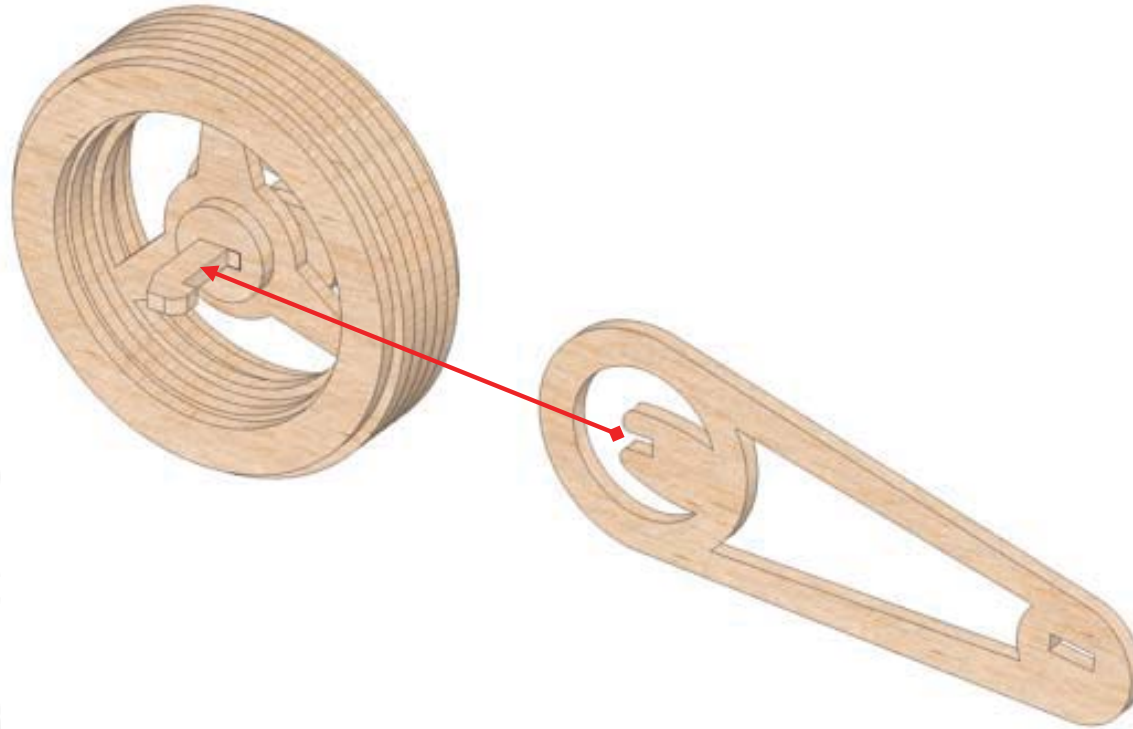

WHEELS  
(BACK)

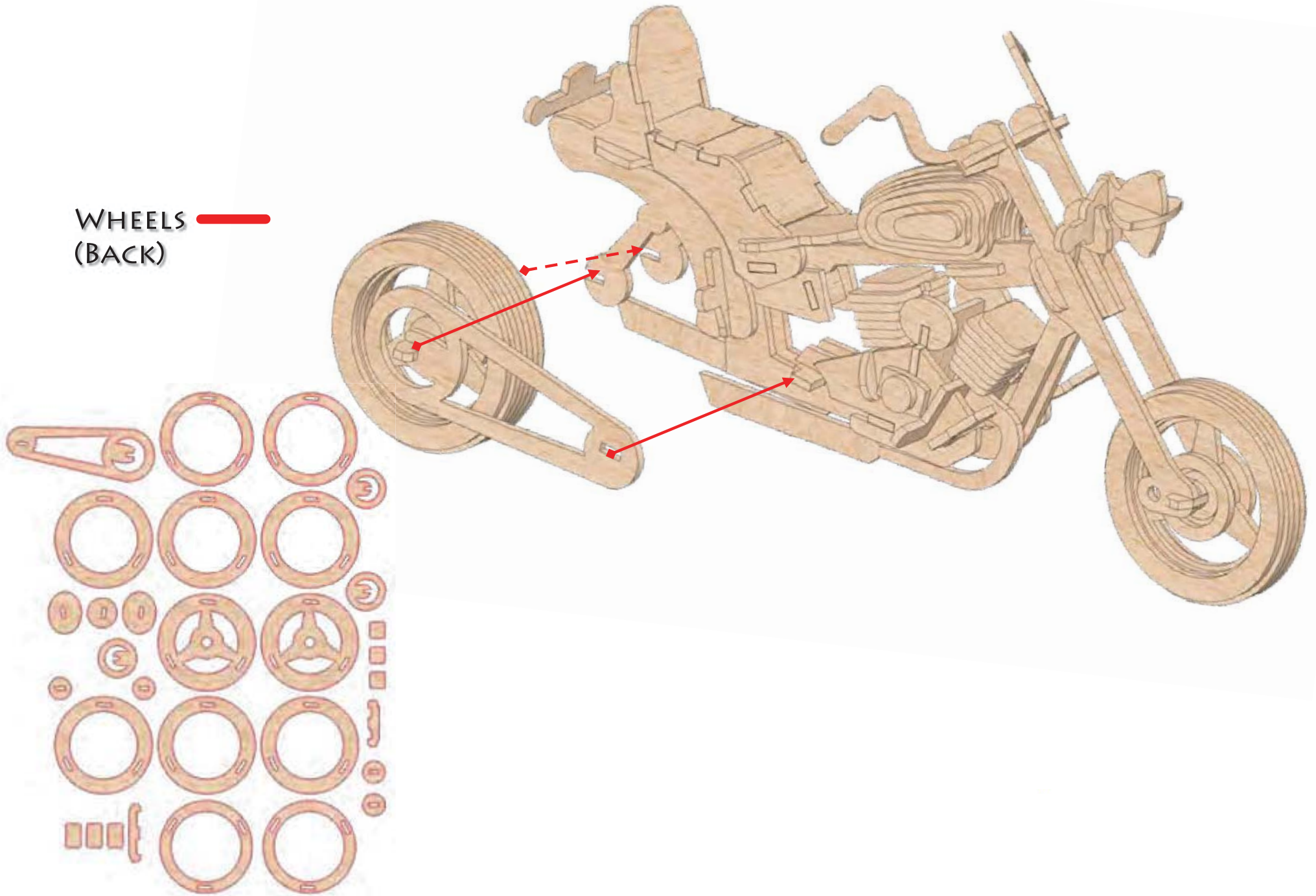

# ASSEMBLY STEPS

WHEELS  
(BACK)

